

## **DURVINIL<sup>®</sup> RFS DRAINAGE PIPES**

**SLOTTED PIPES FOR DRAINAGE, WATER WELLS  
AND PIEZOMETERS**

# DURVINIL® RFS DRAINAGE PIPES

Sireg manufactures a wide range of DURVINIL® RFS slotted pipes, made of rigid high quality and high durability PVC.

- If applied in horizontal position, they have the function of drainage pipes for intercepting and evacuating the groundwater of natural slopes, landslides, retaining structures (berlinoise walls, soil nailings), but also of reinforced concrete works, such as retaining and diaphragm walls, tunnels and embankments.
- If installed in vertical boreholes, they are used as pipes for groundwater pumping wells (diameter > 4") or as piezometers to measure both level and pressure of underground water (diameters < 4").

DURVINIL® RFS pipes are sized in such a way to withstand weight and pressures of the surrounding ground. They have a long life and can resist without any alterations to underground water, as well as to seawater and to acid or diluted alkaline solutions.

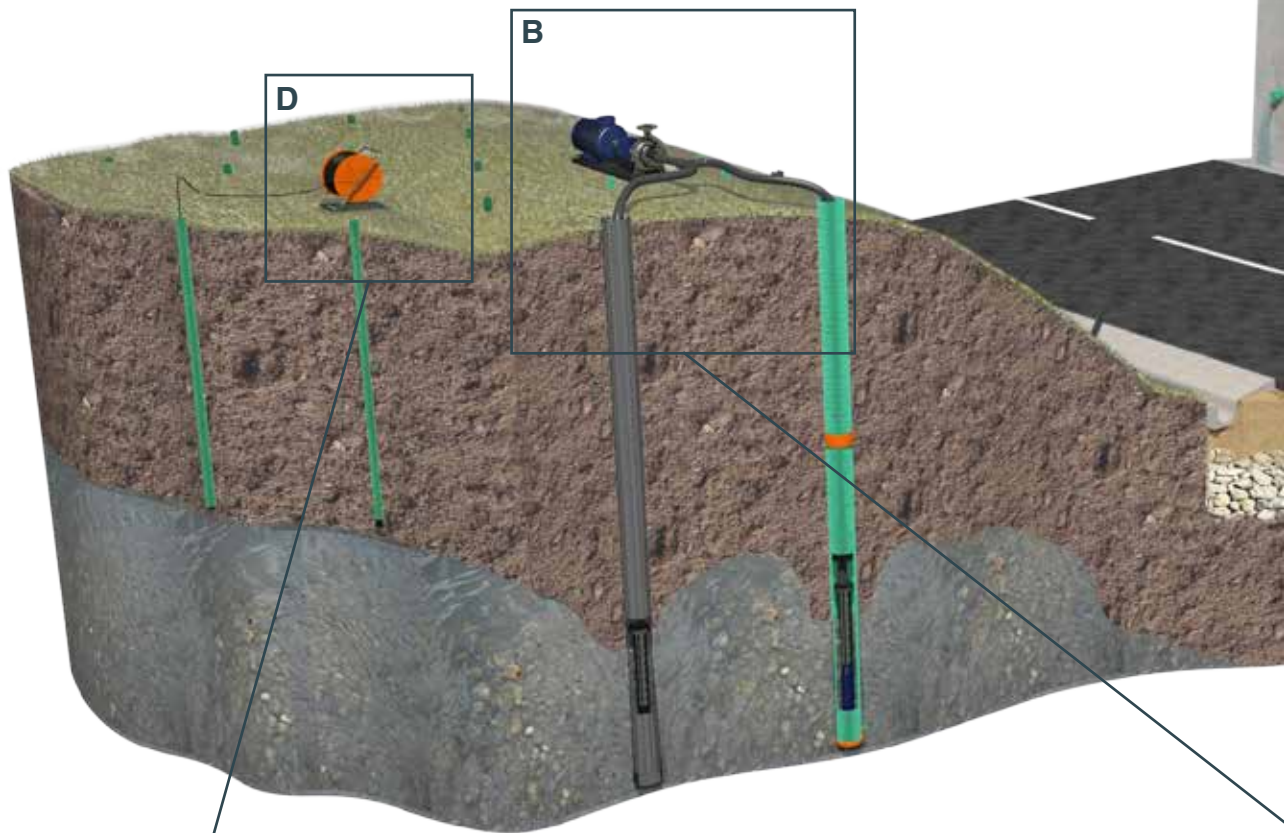

## FITTINGS (PAG.8)



## HORIZONTAL DRAINS (PAG.4)

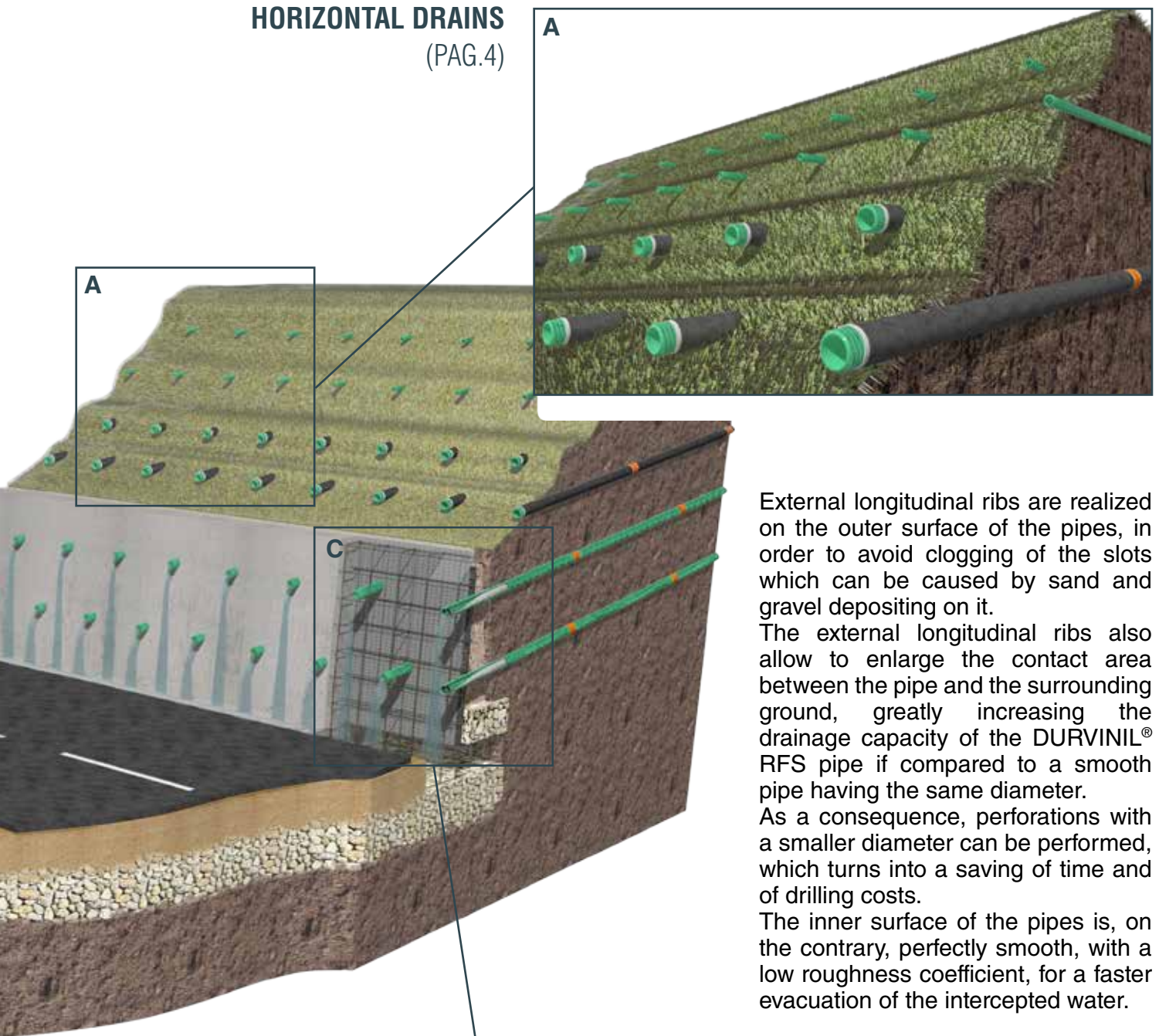

External longitudinal ribs are realized on the outer surface of the pipes, in order to avoid clogging of the slots which can be caused by sand and gravel depositing on it.

The external longitudinal ribs also allow to enlarge the contact area between the pipe and the surrounding ground, greatly increasing the drainage capacity of the DURVINIL® RFS pipe if compared to a smooth pipe having the same diameter.

As a consequence, perforations with a smaller diameter can be performed, which turns into a saving of time and of drilling costs.

The inner surface of the pipes is, on the contrary, perfectly smooth, with a low roughness coefficient, for a faster evacuation of the intercepted water.

## PIPES FOR WATER WELLS (PAG.6)

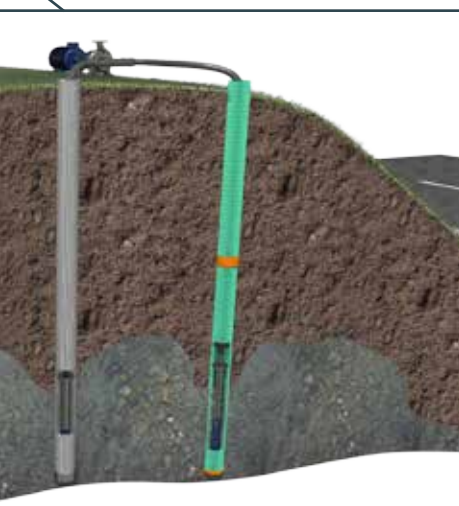

## DOUBLE WALL DRAINAGE PIPES (PAG.7)



# HORIZONTAL DRAINS



The use of slotted drainage pipes is indicated when the excess of water in the soil can cause the degradation of its mechanical characteristics.

DURVINIL® RFS pipes can intercept and evacuate groundwater, lowering pore pressures and thus improving soil stabilization.

The most common use concerns the stabilization of natural and artificial slopes where the pipes are installed in the ground inside horizontal boreholes, even of considerable length (> 50 m).

Center distance, quantity, length of the pipes and size of the slots depend on the type of project, on soil properties and on the amount of water.

For the most complex instability cases, such as in very steep artificial slopes, horizontal drains can be used in association with other drainage (trenches, wells, tunnels) or retaining (walls, diaphragms walls, anchors) works. In all these cases, stability is essentially ensured by the retaining structures, whereas horizontal drains perform the important function of reducing water pressure upstream.

DURVINIL® RFS drains are also used during tunnels excavation where they are installed on the excavation face, on the arch or laterally in the presence of water infiltrations to reduce the hydrostatic pressure of the ground, to the advantage of the stability and security of the tunnel excavation.

Other application fields of drainage pipes are the rehabilitation of road, rail, airport embankments and reinforced concrete works such as tunnels, bridges, docks.



*Drains on bulkhead reinforcement*



*Drains on tunnel masonry vertical structure*

## DRAINAGE CAPACITY OF PIPES SLOTS 1mm

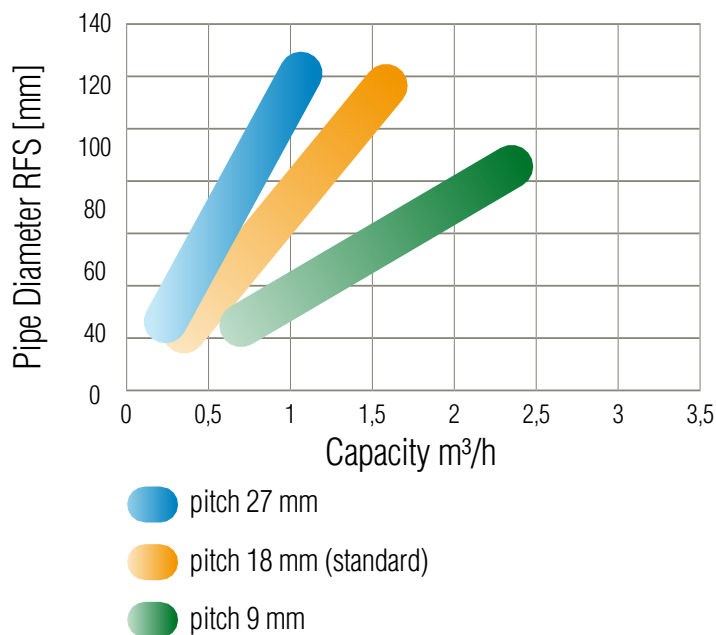

The pipe can be covered by polypropylene filter geotextile having the following features:

**Nonwoven polypropylene geotextile**  
- Weight: 130 g/m<sup>2</sup> +/- 10%

**CROSS DIRECTION TENSILE STRENGTH**  
- Tensile strength: ≥ 5 kN/m  
- Elongation at break: 50%

**MAIN DIRECTION TENSILE STRENGTH**  
- Tensile strength: ≥ 5 kN/m  
- Elongation at break: 50%

**HYDRAULIC CHARACTERISTICS**  
- Speed index: 110 mm/s

Geotextiles having different characteristics are available on demand.

DURVINIL® RFS slotted pipes have diameters ranging from ½” to 10”.

They are supplied in threaded bars of lengths generally between 3 and 6 m and are equipped with ABS high resistance threaded connection sockets.

0.6, 1.0 and 1.5 mm micro slots are realized on 1/3, 2/3 or around the whole pipe circumference, depending on the requirements and on the soil properties.

DURVINIL® RFS slotted pipes can be coated with a filter sock required in loamy, silty-sandy soils or in soils filled with unwashed inert materials.

The filter sock is obtained by sewing of non-woven polypropylene geotextile, it covers the whole pipe and it is characterized by a mass of 130 g / m<sup>2</sup>, in order to ensure proper filtration of the underground water.

### RFS AVAILABLE DIAMETERS

Nominal Diameter [mm]	Inner Diameter [mm]	Outer Diameter [mm]
½”	16	22
¾”	19	27
1”	27	34
1”¼	31	38
1”½	43	50
2”	52	62
2” A	55	62
2”½	66	77
2”½ A	69	77
3”	79	90
3” A	82	90
3”½	91	100
4”	105	118
4” A	108	118

### SLOTS POSITION

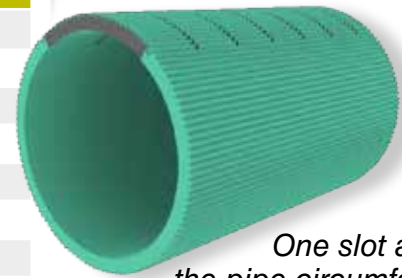

*One slot around the pipe circumference*

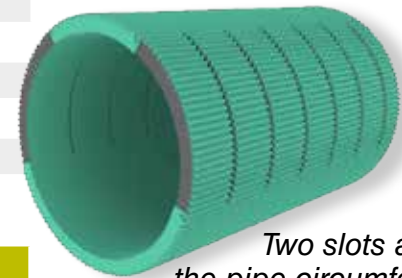

*Two slots around the pipe circumference*

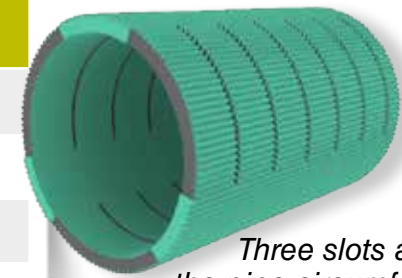

*Three slots around the pipe circumference*

### SUGGESTED DRAIN ACCORDING TO THE DRILLING DIAMETER

Drilling Diameter [mm]	RFS Drainage Pipe Diameter
90 – 130	FROM 1” TO 2”
130 – 160	FROM 2” TO 3”
160 – 200	FROM 3” TO 4”

SLOT [S]: 0,6 mm **1,0 mm** 1,5 mm

PITCH [P]: 9 mm **18 mm** 27 mm

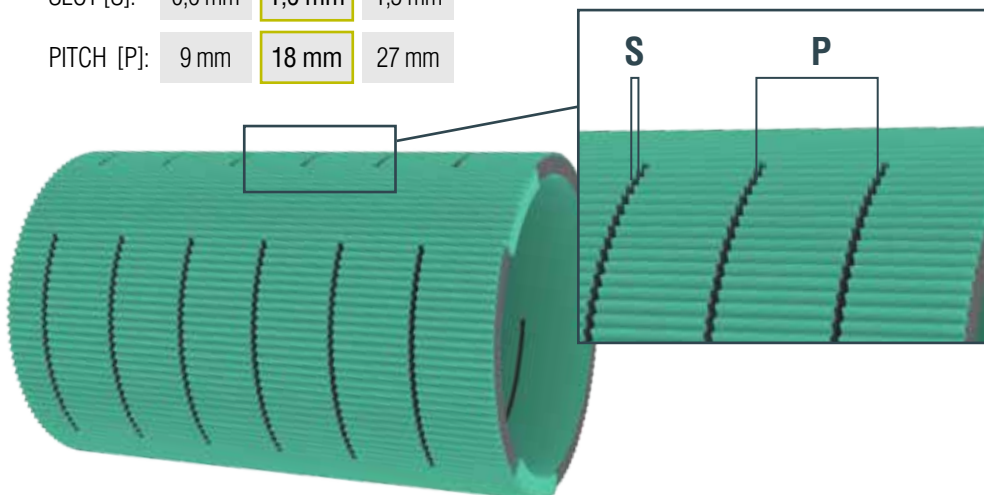

DURVINIL® RFS drainage pipes are produced with slots having width and pitch variable according to the requested drainage capacity and to the soil granulometry.

## PIPES FOR WELLS AND PVC PIEZOMETERS

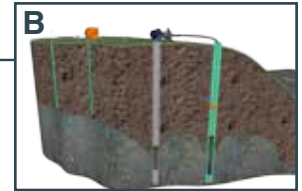

DURVINIL® RFS slotted pipes can be installed inside vertical boreholes with the function of pipes for groundwater pumping wells (diameter > 4") or of piezometers to measure both level and pressure of underground water (diameters < 4").

Pumping wells are made with DURVINIL® RFS pipes and have diameters ranging from 4" to 10". They are equipped with electric submersible pumps in order to lower the underground aquifer or to make continuous water sampling for environmental surveys.

The slots allow underground water to enter the DURVINIL® pipe, but, at the same time, they retain the coarser material which, entering, could clog the well / piezometer.

Slots size depends on the soil granulometry.

The piezometers are realized using DURVINIL® RFS pipes having diameters from ½" to 4". They are used for underground water sampling and for measuring the aquifer quota.

### AVAILABLE DIAMETERS

Nominal Diameter [mm]	Inner Diameter [mm]	Outer Diameter [mm]
5"	129	145
6"	152	170
7"	180	200
8"	205	230
10"	257	285



*DURVINIL® RFS piezometric pipes*

## STEEL SLOTTED SCREENS FOR WELLS

When it is necessary to realize pumping wells of large dimensions (up to diameters of 40"), Sireg offers a wide range of carbon steel and stainless steel screens.

Steel screens, equipped with suitable pumps, are used for water supply or to lower significantly the water table. Sireg range includes steel spiral screens, as well as simple or bridge slotted ones.



## DURVINIL® BIO SYSTEM

Research made it possible to realize biodegradable drainage pipes.

DURVINIL® BIO drains represent the latest development in this field: the pipes are made of bioplastics and they can ensure their functionality for years, thanks to their thickness. At the end of their life, they decompose into simple products and are absorbed by the soil.



# DOUBLE WALL SCREEN DRAINS



DURVINIL® Double Wall Screen filtering system is composed of two PVC concentric slotted pipes coupled by means of threaded flanges.

The annular space between the two pipes is filled with a filter material which may be composed of thermoplastic granules or of quartz sand with controlled granulometry according to the different soil properties.

Double wall DURVINIL® pipes ensure high uniformity and compactness of the filter layer and are very simple to be installed in the borehole.

The filter elements can be easily washed by means of water lances, this allowing a long duration maintenance of the drainage system.

## Possible applications of DURVINIL® DWS pipes:

- drainage of areas already subject to slope movements
- realization of effective drainage systems for heterogeneous sedimentary soils
- recovering of old silted up wells
- realization of permanent drainage systems



*Thermoplastic filter material*



*Installation of DWS double wall drain*



*DURVINIL® DWS double wall drainage pipes*

## DWS AVAILABLE DIAMETERS

Nominal Diameter [mm]	Inner Diameter [mm]	Outer Diameter [mm]	Filter Thickness [mm]	Socket Diameter [mm]
2"	27	62	10,5	69
3"	43	90	16	97
4"	55	118	23	127

## ANCILLARY FITTINGS

Sireg also supplies a series of fittings for the realization of wells and piezometers, such as:

- Safety cover caps for wells
- Boxes for core drilling
- Casagrande cells for pore pressure measurement
- Water level indicator for water tables

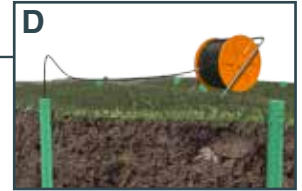

*Aluminium reinforced sockets on double wall drain*



*Safety cover cap*

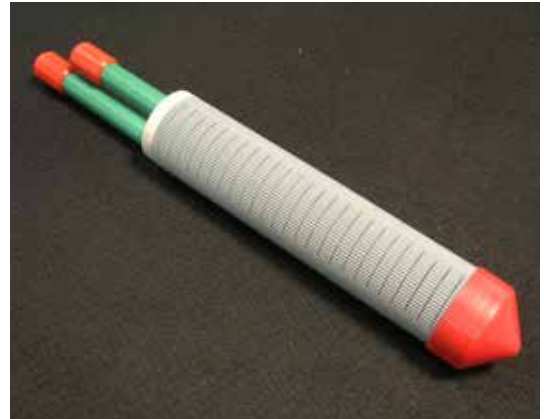

*Casagrande Cell*

## PACKAGING

DURVINIL® RFS pipes are packed on wooden pallets suitable to transport and safe handling of the pipes. Special reinforced packaging can be made on demand.



*DURVINIL® RFS pipes packaging*



*Packaging of DURVINIL® RFS pipes covered with geotextile*



*Carriage in container*



### Sireg SpA

Via del Bruno, 12  
20862 Arcore (MB) - Italy  
Tel. (+39) 039 627021 - Fax (+39) 039 615996  
e-mail: [info@sireg.it](mailto:info@sireg.it) - [www.sireg.it](http://www.sireg.it)

